



**THE REGIONAL TRAINING WORKSHOP ON LARVAL FISH IDENTIFICATION
AND FISH EARLY LIFE HISTORY SCIENCE**

SEAFDEC/TD, SAMUT PRAKAN, THAILAND
16 – 31 MAY 2007

TRD 06: Stereomicroscope User Manual



SMZ168 Series Instruction Manual

Table of Contents

Name of Components	2
Introduction	4
Unpacking	5
Assembly.....	6
Operation	7
Maintenance	17
Troubleshooting.....	21
Moving the microscope.....	23
Repair	23
Warrantee	23

WWW.MOTIC.COM

MOTIC INCORPORATION LTD.

Name of Components

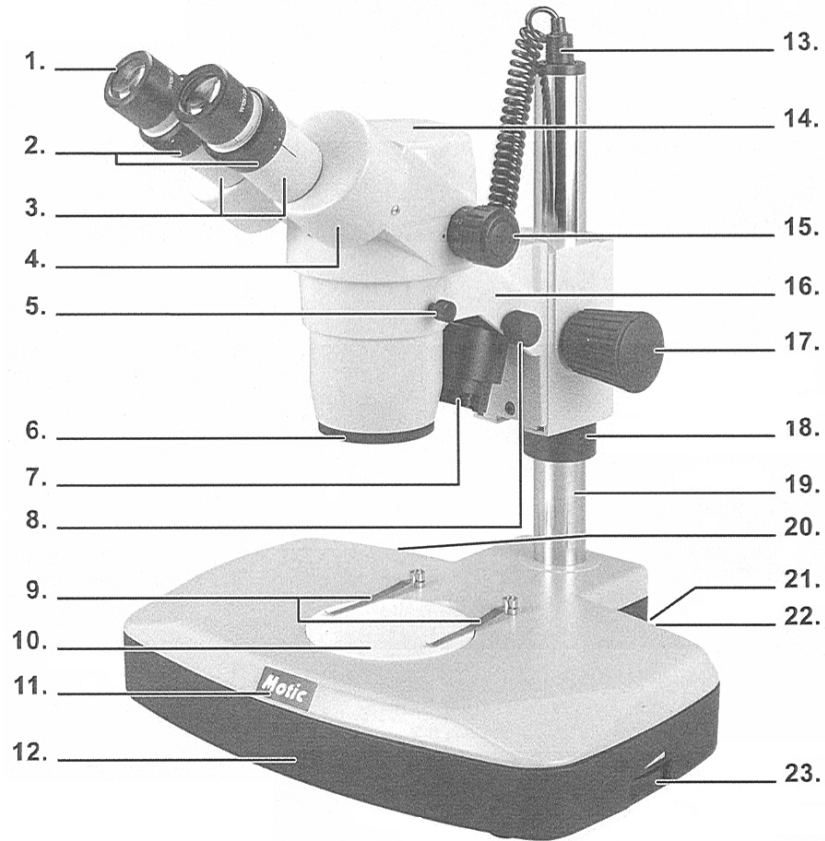

SMZ-168-BL

1. Eyepiece	13. Power cord for incident illumination
2. Diopter adjuster	14. Head
3. Eyepiece tubes	15. Zoom knob
4. Prism housing	16. Head holder
5. Head holder locking screw	17. Focus knob
6. Objectives	18. Support collar
7. Incident illumination	19. Column
8. Incident light adjustment screw	20. On/Off switch
9. Slide stage clips	21. Incident illumination switch (I)
10. Stage	22. Transmitted illumination switch (T)
11. Stage plate locking screw	23. Light intensity control
12. Base	

Introduction

Thank you for your purchase of a **Motic** stereomicroscope. **Motic** stereomicroscopes are precision instruments, subjected to meticulous examination to reach you in perfect condition. Their design combines easy management and optimum functionality with minimum maintenance.

The information contained in this manual is likely to go beyond what the average user needs to know to use the stereomicroscope, however, it is provided to answer any queries that may arise.

Stereomicroscopes are used to study three-dimensional objects, examine small parts, or dissect biological specimens. They also permit the observation of slide specimens.

These instructions should be read carefully before operating the microscope. They will permit you to use your new stereomicroscope to its fullest capabilities. Terminology used to describe components and controls can be found in the diagram on page 2.

These instructions are based on the assembly and use of the SMZ-168 model with additional notes specifically for the other models in the series.

Unpacking

All components of the stereomicroscope have been carefully packed to make sure they reach you in perfect condition. We recommend that you do not discard any of packing containers in case you need to return the microscope or store it for long periods of time; or should it become necessary to transport it to a technical service provider for any repair, or maintenance procedure.

The box should contain the following components:

- **SMZ-168 (Binocular):**
An illuminated base with a pole for a moveable head with illumination. A black and white opaque stage, a binocular head with eyepieces, eyepiece protectors, a frosted glass stage, a blue filter, a protective cover and a 1.5mm hexagonal key.
- **SMZ-168 (Trinocular):**
An illuminated base with a pole for a moveable head with illumination. A black and white opaque stage, a trinocular head with eyepieces, eyepiece protectors, a frosted glass stage, a blue filter, a protective cover and a 1.5mm hexagonal key.

Remove and handle all components of the microscope with extreme care.

Avoid touching the lenses of the optical elements and keep clear of dust, water or other contaminating agents, as they could stain, or damage the lens surface and affect the quality of the image.

Assembly

All the steps described for the assembly of the stereomicroscope must be undertaken with extreme care, and without forcing the placement of the distinct parts and elements of the stereomicroscope.

- A. Place the base of the microscope (13) upright on a flat, stable and clean surface.
- B. Loosen the head holder locking screw (5) and place the head (14) in the head holder (17) with extreme care.
- C. Tighten the head holder locking screw (5).
- D. Connect the incident illumination to power cord (15) located at the upper part of the column (21).

Warning: Before connecting the stereomicroscope to a power source, always check that the voltage coincides with that of the stereomicroscope.

Operation

A. Starting Up

The stereomicroscope has two stages. One is frosted glass and is used for the observation of microscope slides or samples that are thin or transparent, such as leaves, insect wings, etc. The black and white stage is used for non-transparent objects, or for dissection. For best contrast, choose the side of the stage to best suited for use.

Warning: Transmitted illumination can **ONLY** be used with the frosted glass stage. The Heat generated by the transmitted illumination can melt or damage the black and white stage. Such damage would not be covered under warrantee.

1. Changing the stage.
 - a. Loosen the stage plate locking screw (12) and remove the stage (11).
 - b. If wishing to use the glass stage, insert the blue filter in the centre of the base with the frosted surface facing down.
 - c. Place the glass stage with the frosted surface, again, facing down.
 - d. Retighten the stage plate locking screw.
2. Before connecting the stereomicroscope to a power source, adjust the light intensity to its minimum (24). This must be repeated every time the stereomicroscope is turned on or off, to prolong the life of the bulb.

Three light switches are located on the base of the microscope.

MAIN : The principal switch, which turns the whole unit on or off.

I : Turns incident light on or off. (Illumination from above)

T : Turns transmitted illumination on or off (illumination from below)

3. Press the principal switch (9) to the **ON** position “**I**”.
4. Press the incident illumination (22) or transmitted illumination (23) or both at the same time “**I**” or “**II**”, according to your needs in observing the sample.
5. Light intensity should be adjusted according to the objective used, or the type of sample observed.
6. The angle of incident illumination can be adjusted by using the adjustment screw (8) which can be used to vary the orientation of the lens.

B. Interpupillary adjustment

1. Looking through the eyepiece (1), move the eyepiece tubes (3) by taking hold of the prism housing (4) and moving outwards or inwards.
2. Interpupillary distance is correct when the two fields of view observed through both eyepieces appear complete, and are unified into one.
3. Interpupillary distance should be adjusted for each new user.

C. Focusing

1. Turn the zoom knob (16) to the lowest magnification 0.75X.
2. Place a flat object or a microscope slide on the centre of the stage (11).
3. Turn focusing knobs (18) to mid-focus range.

4. The head holder (17) is mounted on a column (21), on which it can be moved up or down, depending on the size of the object to be focused on.

- a. Support the head holder (17) with one hand without touching any lens, and with the other, loosen the screw (20) on the support collar (19). The head holder can then be slid to the base (13).
- b. Without letting go of the head, loosen the head holder locking screw. (Fig.1)

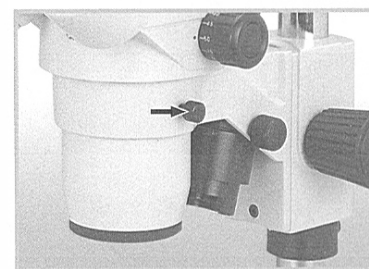

Fig.1

- c. While looking through the eyepiece, move the head holder up or down until the object appears in focus.
 - d. Tighten the head holder locking screw. Do not let go of the head yet.
 - e. Slide the security collar up to the head holder, and tighten the support collar screw. The head can then be released.
 - f. It is not necessary to adjust the head every time the sample is changed, only when it appears out of focus.
5. Adjust the focus knobs, (18) until the image appears sharp.

D. Diopter adjustment

Diopter adjustment collars are located on the eyepiece tubes. Their normal position is when the lower part of the collar is aligned with the sign marked on the eyepiece tube.

For differences in eyesight:

1. Using only the right eye, look through the right eyepiece (1) and adjust the focus.
2. Next, using the left eye, look through the eyepiece and adjust the focus by turning the diopter adjuster (2) located on the left-hand tube (3) until the image appears sharp. Do not use the focus knobs to adjust focus (18).

E. Changing magnification

1. Turn the zoom control (16) to the highest magnification, 4X.
2. Although the stereomicroscope has been parfocalised, focus will have to be adjusted as the objectives of a low magnification offer a more profound field of view. The profundity of the field is the capacity to focus on different points on different levels.
3. Once the image is in focus with the higher magnification objectives it is not necessary to adjust the focus when lower magnification objectives are used.

Adapting a photographic, or a video camera (Only for model SMZ-168TL)

The model SMZ-168 TL comes equipped with a vertical image port on the head for the installation of a photographic reflex type camera, or video camera, using the corresponding adapters.

At the back of the head there is a selection lever (Fig. 2) that transmits the image to the vertical port. In an extended position the image is transmitted to the vertical port, and the image cannot be seen by the right eyepiece.

- A. To adapt a photographic camera an adapter tube is needed. This tube includes 2X lenses to balance the correct parfocality between the images received by the binocular and vertical ports. This balance can be achieved providing that the parfocality has been adjusted correctly, as described in point “**D. Changing magnification**” in this manual.

The adapter tube has a T type thread at one end where adapter mounts of all types can be adapted for all reflex camera brand names on the market.

NB: The T type adapter mount is not included as it is an item specific to each brand of camera on the market

1. To connect the camera to the microscope, first remove the front lens of the camera, and replace with the corresponding T mount. Screw on the adapter tube provided, onto the mount of the camera.
2. Loosen the knurled screw (Fig.2), situated on the side of the vertical port on the head, sufficiently enough to remove the protective cover.

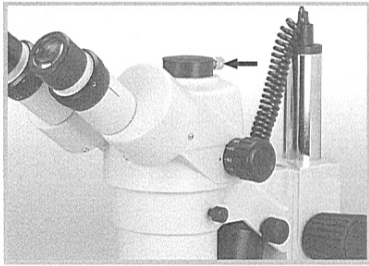

Fig.2

3. Insert the adapter tube with the camera already mounted onto the vertical port. If it does not insert easily, unscrew the knurled screw until the adapter tube fits perfectly.
4. Re-tighten the knurled screw, so that the camera is secure.
5. Operate the camera according to the manufacturers' instructions.

- B. To adapt a video camera, an adapter tube is needed. This adapter tube includes 0.5X lenses that correct the parfocality of images, from both binocular and vertical ports, shown on the TV monitor. This is providing that parfocality has been correctly adjusted according to the steps followed in point **“D. Changing magnification”** in this manual.

The adapter tube is provided with a “C” thread, and a “CS” ring which can adapt different kinds of video camera.

To connect the camera to the microscope, screw the adapter tube to the video camera.

1. Loosen the knurled screw (Fig.2) on the side of the vertical port of the head sufficiently enough to remove the protective cover.
2. Insert the adapter tube with the camera already mounted on the vertical port, as shown in figure 4. If it does not insert easily, unscrew the knurled screw until the adapter tube fits perfectly.
3. Re-tighten the knurled screw firmly, so that the camera is secure.
4. Operate the camera according to manufacturers' instructions.

If the image on the monitor appears out of focus when the objective is changed, it is possible that the CS mount is responsible. Place, or remove it, according to the procedure to obtain parfocality.

Adapting the Motic K2401 Fluorescent Ring Illuminator

The SMZ-168 comes equipped with a screw type objective system at the bottom of the optical tube for the installation of auxiliary objectives, or the K2401 Fluorescent Ring Illuminator with corresponding adapter.

- A. To adapt an auxiliary objective, the auxiliary objective must be a screw mount type to ensure secure mount.
 1. To mount the auxiliary objective to the microscope, first remove the protective glass of the optical tube by unscrewing anti-clockwise.
 2. Screw on the appropriate auxiliary objective by turning the objective [threads facing up] clockwise to secure the objective to the optical tube. There is no need for replacing the protective glass.
 3. Adjust the working distance accordingly with the magnification in use and the properties of the objective by turning the coarse focus either clockwise or anti-clockwise until the sample is in focus. Refer to figure 3 for the corresponding working distance for specific objectives.

If the image appears out of focus or slanted when the viewed after installing an auxiliary objective, it is possible the objective may be mounted incorrectly. Remove the objective and refasten with care to ensure proper alignment.



Fig.2: Auxiliary Objective

Standard Objective	Additional Objectives				
	0.3X	0.5X	0.75X	1.5X	2X
113mm	343mm	200mm	130mm	54mm	34.5mm

Fig. 3: Working Distances and Auxiliary Objectives

- B. To adapt the K2401 Fluorescent Ring Illuminator an SMZ-168 ring adapter is needed. This ring adapter will replace the prior installed fastening mechanisms.

NB: The SMZ-168 ring illuminator adapter is not included in the K2401 Fluorescent Ring Illuminator kit as it is a specific model adapter.

1. To connect the K2401 Fluorescent Ring Illuminator, first remove the prior installed mounting mechanism by turning the screw mount ring in an anti-clockwise motion while holding the locking ring located at the bottom of the light.
2. Remove the protective glass of the optical tube by unscrewing anti-clockwise.
3. Place the ring illuminator underneath the optical tube. The ring illuminator is not secured yet. Secure the ring illuminator to the optical tube by screwing clockwise, from the bottom of the ring illuminator, the SMZ-168 adapter ring to the optical tube. The ring illuminator is secured when the adapter becomes tight.

4. Adjust the position of the ring illuminator to avoid interference with focusing and zoom knobs by slightly turning with your hand.
5. Plug the ring illuminator into the nearest electrical outlet free from debris.
6. Turn the ring illuminator on by pressing the principal to “O” for on.
7. Adjust the microscope with focusing knobs to achieved desired illumination effect and clarity.

If the ring illuminator does not turn on, check whether the outlet has be switched to on. If still no illumination, unplug the ring illuminator. Then unscrew the SMZ-168 adapter ring by turning anti-clockwise while safely holding the ring illuminator by the handle end. Once remove, inspect the bulb of the ring illuminator for signs of malfunction or burnout.

Maintenance

Warning: For your own safety switch off and disconnect the microscope from any electrical source before attempting any maintenance procedure to avoid the risk of electrocution.

Consult your distributor if any repair or maintenance procedure is required to your microscope that does not appear in this instruction manual.

A. Optical maintenance

Do not attempt to disassemble any optical component. For any repair work not specified in this manual, consult the technical service responsible in your area.

Before cleaning the lens surface, remove dust with a brush specifically for lenses, or with low pressure compressed air, found in any photography shop.

1. Cleaning the eyepiece

- a. Do not remove the eyepiece (1) from the eyepiece tube (3).
- b. Clean the external surface by dampening the lens with one's breath.
- c. Afterwards, dry the lens with special lens paper. Dry in circular movements from the centre of the lens, outwards. Do not wipe the lens when already dry, as they scratch easily.

2. Cleaning the objectives.

- a. Do not remove objectives from the microscope.
- b. Only clean the surface area. Use a soft cotton cloth dampened slightly with **Xylene**. Dry the lens afterwards with the same cloth.

B. Electrical maintenance

1. Changing the bulb

- *Changing the transmitted illumination bulb. [DIAGRAM?]*

- Rest the stereomicroscope on its side being extremely careful, especially with the eyepiece (1) and the stage (11).
- Unscrew the 6 screws and open the cap on the base.
- With a cloth, carefully pull out the bulb by disconnecting it from the socket.
- Do not touch the new bulb with your hands. Use a clean cloth to insert the pins of the bulb into the socket.
- If the bulb is accidentally touched with bare hands, it must be cleaned, as this could affect the transmission of light, and life span of the bulb.
- Close the cover on the base and screw down firmly.

- *Changing incident illumination bulb*

- Unscrew the illuminator protection tube (7), turning it anti-clockwise, and removing the tube from that of the lenses.

Illuminator
Protection Tube

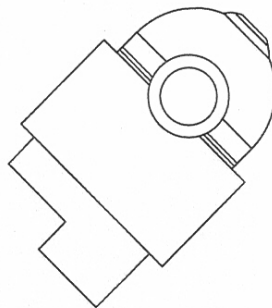

Fig.4 Incident Light

- With a cloth carefully pull out the bulb to disconnect it from the socket.
- If the bulb is accidentally touched with bare hands, it must be cleaned, as this could affect the transmission of light, and life span of the bulb.
- Replace the illuminator lens tube by, turning clockwise to screw in the protector tube.

2. Changing the fuse.

- With a flat screwdriver, lightly press on the slot of the fuse holder cover and turn 1/4 in the direction of the arrow marked.
- Release pressure and completely remove the loosened cover.
- Remove the fuse from the removed cover, and insert the new one, ensure that it is 0.5 Amps.
- Insert the cover.
- Repeat step (a.) but turning 1/4 in the opposite direction to the arrow. The cover must be firmly closed.

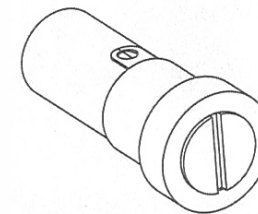

Fig.5: Fuse Appearance

C. Mechanical maintenance

1. Adjusting the tension of the focus.

Tension comes pre-adjusted by the factory. The best point of tension is that which permits the focus knobs to move as loosely as possible, without the head sliding down with its own weight.

The tension adjustment collar for focussing (Fig.1) is situated between the focussing knob (18) and the head holder (17).

- a. Loosen the screw located in the collar hole with the 2mm hexagonal key.
- b. To increase the tension, turn the collar anti-clockwise; to decrease it, turn the collar clockwise.
- c. Re-tighten the hexagonal key.

Troubleshooting

Electrical Problems

Problem	Cause	Solution
The bulb does not work	<ul style="list-style-type: none"> ● Outlet inoperative. ● Cable not connected ● Bulb burned out ● Fuse blown ● Wrong Bulb 	<ul style="list-style-type: none"> ● Have it repaired by a qualified specialised technician ● Connect the cable to the power source ● Replace bulb ● Replace fuse ● Replace with appropriate bulb
Bulb has short life span	Very high voltage	Reduce light intensity to the minimum before turning on or off the stereomicroscope
Bulb burns out immediately	Wrong bulb	Replace with the appropriate bulb
Bulb flickers	<ul style="list-style-type: none"> ● The bulb is not inserted correctly into socket ● Bulb on the point of burning out ● Fuse cover badly closed ● Bad connection with power source 	<ul style="list-style-type: none"> ● Insert bulb correctly ● Replace bulb ● Close correctly ● Have repaired by a qualified specialised technician
Fuse blown quickly	Wrong fuse	Replace with appropriate fuse
Fuse blown instantly	Short circuit	Have repaired by a qualified specialised technician

Image Quality

Problem	Cause	Solution
Poor resolution	<ul style="list-style-type: none">• Eyepieces dirty• Objectives dirty	<ul style="list-style-type: none">• Clean eyepieces• Clean objectives
Spots, or stains in field of view	Eyepieces dirty	Clean eyepieces

** NB. Stains in field of view may also be attributed to dirt on the inside of the eyepiece. It is recommended therefore that the lens be cleaned by a recognised service technician.*

Mechanical Problems

Problem	Cause	Solution
It does not stay in focus	The head drops down	Adjust the tension of the coarse focus knob

Moving the microscope

- If possible, avoid moving the stereomicroscope.
- Carry the stereomicroscope in both hands. One hand should hold the stereomicroscope column (21), and the other should support it under the base (13).
- Maintain the stereomicroscope in a vertical position.

Repair

If the stereomicroscope needs repairing, or revision by authorised personnel, we would recommend that it be stored in its polystyrene box and returned to the distributor. Attach a note with a description of the problem, or details of the required revision.

Warranty

All **Motic** microscopes are warranted against any manufacturing defect for a 5 year period. Damage occurring by any unauthorised repair work, or occurring through misuse or modification of the microscope will not be included under the conditions of the warranty. Bulbs and fuses are not under warranty.

The warranty service is provided by **Motic**, or its authorised distributors. Defective products will be repaired free of charge when returned to **Motic**, or one of its distributors. Transport costs will be covered by the purchaser.

Owing to possible modifications and improvements in their manufacture, changes may occur to stereomicroscopes without prior notice.

		SMZ-168	SMZ-168-60	SMZ-168 T
Microscope body	Magnification	0.75x - 5x		
	Zoom ratio	6.7 : 1		
	Working distance	113mm		
	Tube inclination angle	35°	60°	35°
	Interpupillary distance adjustment	Diopter Adjustment both eyes: ±5 Interpupillary adjustment: 52mm to 79mm		
	Video camera adaptability	-	-	C-mount [CCD 0.3X / CCD 0.65X not included]
	Zoom Adjustment Knob	Left/right - single shaft horizontal knob Interpupillary distance high/low magnification stopper incorporated		
	Auxiliary objective	Mounting by screwing the thread at the bottom of frame		
Eyepiece	WF 10X/23 High Eyepoint			
Stand		168P	168L	
		Streamed line stand	Transmitted illumination stand	
	Frame Installation	Mounting diameter: 76mm		
	Focusing Adjustment	50mm vertical movement		
	Stage plate	Black & white Frosted glass plate	Black & white Frosted glass plate	
	Light source	Cold light illumination [optional] / Fluorescent ring illuminator attachable [optional]	Transmitted illumination: Halogen Reflected illumination: Halogen Input rating: 12V/10W	

Motic

NO.: SP010986

Motic Incorporation Ltd. (Hong Kong)

Rm 2907-8, Windsor House, 311 Gloucester Road, Causeway Bay, Hong Kong Tel: 852-2837 0888 Fax: 852-2882 2792

Motic Instruments Inc. (Canada)

180-4320 Viking Way Richmond, B.C. V6V 2L4 Canada Tel: 1-877-977 4717 Fax: 1-604-303 9043

For inquiries in UK (UK)

Saracens House, 25 St. Margarets Green, Ipswich, IP4 2BN, Suffolk, UK Tel: 44-(0)-14732 81909 Fax: 44-(0)-14732-11508

Motic Deutschland GmbH (Germany)

Gewerbepark Spilburg, Spilburgstrasse 1 D-35578 Wetzlar Germany Tel: 49-6441-210 010 Fax: 49-6441-210 0122

Motic Spain, S.L. (Spain)

C/Pere IV, 78-84-7 Planta 08005 Barcelona Spain Tel: 34-93-485 1841 Fax: 34-93-309 7700

URL: <http://www.motic.com>

E-mail: info@speedfair.com

Motic China Group., Ltd. (China)

Motic Building, Torch Hi-Tech Industrial, Development Zone, Xiamen P.R.C. Tel: 86-0592-562 7866 Fax: 86-0592-562 7855

© 2001-2002 Motic China Group Co., Ltd. All rights reserved. Motic is a registered trademark and service mark of Motic China Group Co., Ltd. Microsoft Windows logo are registered trademarks of Microsoft Corporation. All other trademarks are the property of their respective owners.

Design Change: The manufacturer reserves the right to make changes in instrument design in accordance with scientific and mechanical progress, without notice and without obligation.

SAFETY INSTRUCTIONS FOR USING THE COMPOUND MICROSCOPE

In order to fully utilize your microscope safely, please notice the following important instructions before starting with the microscope.

A. Before turning on the power

Plug the electrical connection of the stand or light source to the electrical supply. **Before plugging and turning on the power, make sure that the operation voltage of the microscope does match with the voltage supply.**

B. Changing the bulb

1. Before changing the bulb, **make sure that the power switch is off and the power cord has been disconnected from the main supply.**
2. Carefully remove the old light bulb from the socket and plug the new bulb in.
3. **Never touch the glass surface of the bulb with naked hand.** Any grease stain brought onto the bulb by the naked hand will negatively affect the heat dissipation and, thus, greatly shorten the life span of the bulb. Clean the bulb surface with alcohol and tissue if the user has touched the bulb surface accidentally.
4. Specifications of light bulb can be found on the surface of the microscope. If required, please contact your local agent for supply of new light bulbs.

C. Care and cleaning of the microscope

To take good care of the microscope, the user should avoid the attack of **dust and water**. If dust and water come to the microscope, **fungus** will eventually grow and kill the microscope. Please notice that once fungus is grown, even after cleaning, the microscope will have a good chance to be re-infected again. Moreover, **grease stain** and **fingerprints** will distort the image, which should be avoided.

1. Protection against dust

When the instrument is not used for a long period of time, cover it with the enclosed dust cover. Never leave the eyepiece tube open without any covers. Either leave the eyepiece in the tube (recommended if the microscope is used very frequently) or cover it with wrapping paper or covering cap. Eyepieces and other optical accessories, when not in use, are recommended to be kept in a dry box to protect them against dust and water.

2. Protection against water

The instrument should be kept away from water source, pipeline or water sink. Humidity in the room where the instrument is located should be as low as possible (relative humidity should be kept below 70 %). All the optical accessories are recommended to be kept in a dry box when not in use. The use of dehumidifier and 24-hour air conditioning is highly recommended if the surrounding is very humid.

3. Cleaning

- a. If dust is found on the optical surface, try to remove it by air blower or compressed air.

- b. For fingerprints, grease stain or dust which cannot be removed by air blower, two possible methods are recommended:-
- Breathe lightly on the glass surface and wipe with a piece of clean cloth, lens paper or cotton swab. Please notice that small cotton fibre may be left onto the lens surface if a cotton swab is used.
 - Dip a cotton swab or lens paper with a small amount of **absolute alcohol**, and clean the lens surface carefully. No other aggressive solvents should be used.

In no circumstances should the user clean any lens surface with dry cotton swab, cloth or lens paper. This will scratch the lens surface causing irreparable damage. Water is not recommended for cleaning of lens as it will leave some water stain on the lens surface and if water residue is left on the lens, fungus can grow causing irreparable damage.

4. Moving the microscope

- a. The microscope should not be moved around whenever it is possible.
- b. If moving is unavoidable, the user should ensure that, before moving, the eyepieces are firmly locked in the eyepiece tube and all objectives are tightly screwed onto the nosepiece.
- c. The user should move the microscope with both hands, one hand holding the bottom of the stand and the other hand holding the upper limb of the microscope. When moving the microscope, it is always best to have the eyepiece tube facing" away from the user.

- d. The microscope should always be kept vertical when being moved.

5. Electrical parts of the microscope

- a. Before plugging in the power cord with the supply, make sure that the supplying voltage matches with the operation voltage of the equipment.
- b. Turn off the equipment before plugging in the power card with the supply.
- c. The best practice is to turn the voltage down to the lowest before turning off the equipment.
- d. Do not turn the power on and off, off and on immediately as this will shorten the life span of the bulbs and may cause damage to the electrical system.
- e. Users should observe all local safety regulations of the region. The equipment is manufactured according to CE, UL and other Safety Instruction. However, users do have full responsibility to use this equipment safely.

*** * SHOULD YOU HAVE ANY PROBLEMS CONCERNING USING THE MICROSCOPE, PLEASE CONTACT YOUR AGENT IMMEDIATELY. WE ARE ALWAYS READY TO HELP IN ALL ASPECTS. * ***

*** * BECAUSE OF TECHNOLOGICAL ADVANCEMENT, THESE SAFETY INSTRUCTIONS ARE SUBJECT TO CHANGE WITHOUT PRIOR NOTICE AND WITHOUT OBLIGATION. * ***

YOUR LOCAL AGENT:-

Motic®

SMZ-168 Series

1:6.7 Zoom Ratio Stereomicroscope



SMZ-168 STANDARD FEATURES

OPTICAL SYSTEM

- High Resolution Stereo Image
- Zoom Magnification Click Stops
- Standard Observation angle of 35°
SMZ-168-BL (60) Observation angle of 60°
- Diopter Adjustment on both eye tubes: ± 5
- Adjustable interpupillary distance: 52mm - 75mm
SMZ-168-BL (60) Adjustable interpupillary distance: 52.5mm ~ 75mm
- Zoom Magnification Range: 0.75X - 5X
- Zoom Ratio: 1 : 6.7
- Working Distance: 113mm
- Anti-Fungus Properties

EYEPIECES

- Widefield High Eye Point 10X/23

FOCUSING BLOCK

- Ball bearing focusing mechanisms
- 50mm focusing range
- 76mm inner head mount
- 12V/10W Halogen incident light

BASE STAND

- Streamlined base stand
- Large working area
- 12V/10W Halogen transmitted light [intensity control]
- Universal power input 110V - 220V



SMZ-168-BL
Binocular Stereomicroscope



SMZ-168-TL
Trinocular Stereomicroscope



SMZ-168-BL (60)
Binocular 60° Observation
Stereomicroscope

SMZ-168 Series Advanced Zoom Stereo Microscopes Standard Configuration

	Order Number	SMZ-168BL	SMZ-168TP	SMZ-168TL
Binocular zoom body	AX66.02601	●		
Trinocular zoom body	AX68.02601		●	●
Head holder with incident light halogen 12V/10W (**works only with AX40.00002**)	AX66.02605A	●		●
Head holder without incident light	AX66.02605B		●	
Streamlined base stand	SW01.09K3		●	
Streamlined base stand with transmitted light halogen 12V/10W	AK40.00007	●		●

SMZ-168 SCHEMATIC DIAGRAM

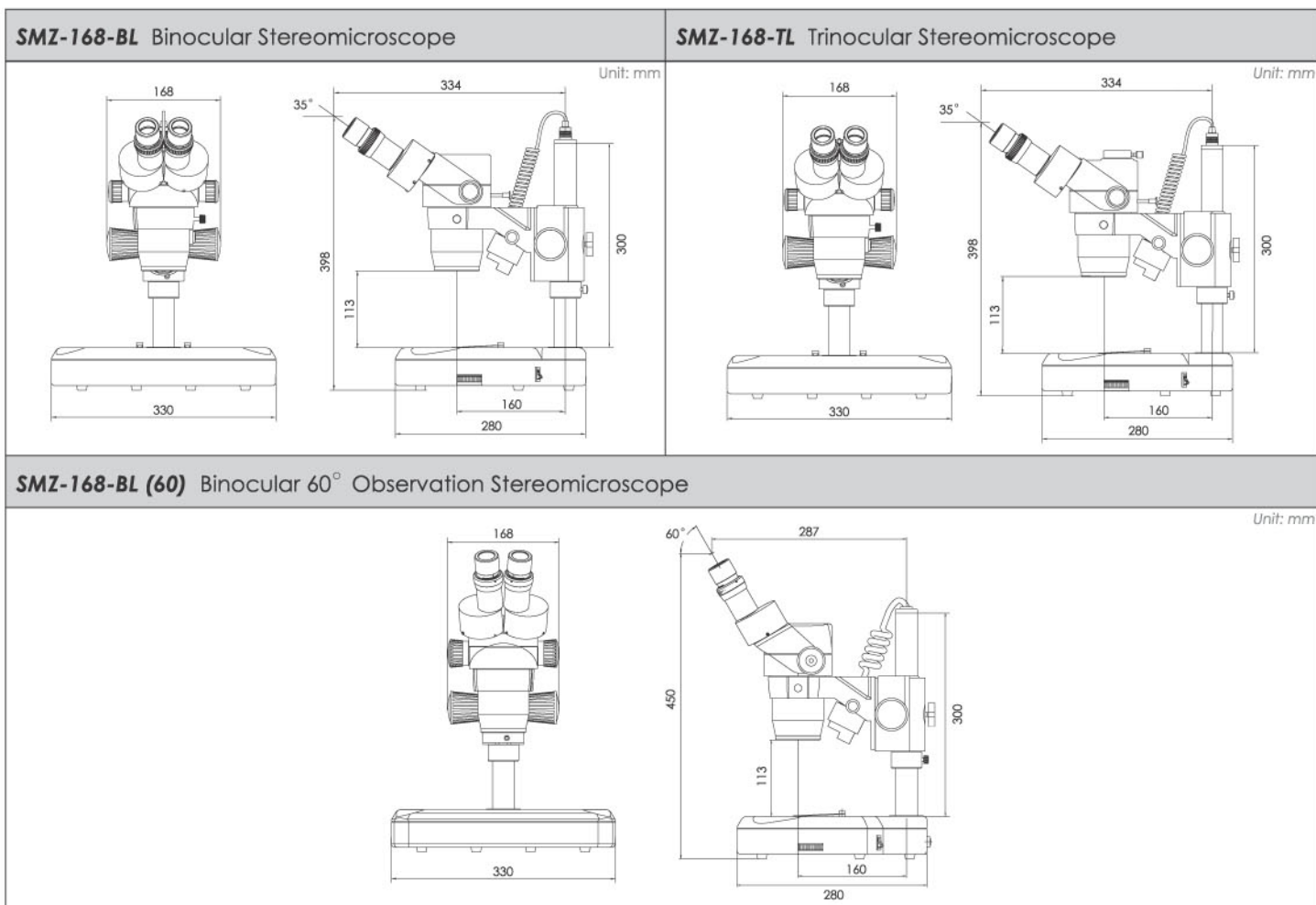

SMZ-168 SPECIFICATIONS

	SMZ-168 BL		SMZ-168 TL			SMZ-168 BL (60)	
Optical System	GREENOUGH						
Magnification Range	2.25X - 320X						
Zoom body magnification	0.75X - 5X						
Zoom Ratio	1 : 6.7						
Eyepieces	WF 10X/23 High eye point						
Interpupillary distance	52mm - 75mm						
Diopter adjustment	±5°						
Observation angle	35°					60°	
Working Distance	113mm						
Choice of eyepieces	5X/23	6.25X/23	10X/21	15X/17	20X/13	30X/8	32X/8
Additional objectives available	0.3X WD = 324mm						
	0.5X WD = 192mm						
	0.63X WD = 156mm						
	0.75X WD = 127mm						
	1.5X WD = 50 mm						
	2X WD = 34.5 mm						
Max. Magnification	320X						
Max. field of view	102 mm						
Max. working distance	324 mm						
Top light	12V / 10W Halogen [Reflected]						
Bottom Light	12V / 10W Halogen						
Photo and Video adapters	2X Photo Adapter						
	0.35x CCD Adapter [for 1/3" CCD]						
	0.65x CCD Adapter [for 1/2" CCD]						

CAMERA ADAPTERS

		
2X Photo Adapter 35mm SLR Camera AX6602603	0.35X CCD Adapter 1/3" CCD Camera AX6602602	0.65X CCD Adapter 1/2" CCD Camera SW0113R5

AUXILIARY OBJECTIVES

		
		
0.3X W.D. 324mm AX6602607	0.5X W.D. 192mm AX6602608	0.63X W.D. 156mm AX6602643
0.75X W.D. 127mm AX6602609	1.5X W.D. 50mm AX6602610	2X W.D. 34.5mm AX6602611

GLIDING STAGE

<ul style="list-style-type: none"> ■ Base stand mountable ■ Hand movable ■ 360° rotatable for various observations 	 SW010308
---	--





MECHANICAL STAGE

<ul style="list-style-type: none"> ■ Base stand mountable ■ Max. X distance: 75mm ■ Max. Y distance: 50mm ■ Dimension in mm: 222.8(w) x 170(l) x 29.5(h) 	 SW010338K
--	---

EYEPIECES

WF6.25X / 23mm	SG02T0103	
WF10X / 23mm	SG02T0218	
WF15X / 17mm	SG02T0318	
WF20X / 13mm	SG02T0406	
WF32X / 8mm	SG02T0502	

MEASURING EYEPIECES

			
360° : 10° [SG060314]	10mm:0.1mm [SG060312]	14mm : 0.2mm [SG060320]	14mm : 0.1mm [SG060315]

POLARISING EQUIPMENT

<ul style="list-style-type: none"> ■ Base stand mountable 1-piece set ■ 360° independently rotatable polariser [top] ■ 360° independently rotatable analyser [bottom] 	 SP080013K
--	--

DARKFIELD ATTACHMENT

<ul style="list-style-type: none"> ■ Conical glossy central stop for diffracted light observation ■ Iris diaphragm for controlling the shape of light ■ Base stand mountable 	 SP090001
---	--

POLARISING SET

<ul style="list-style-type: none"> ■ Zoom body screw mount polariser ■ Base stand mountable 360° rotatable analyser 	 AX6602633
---	---

JEWELLERY CLIP

<ul style="list-style-type: none"> ■ Easily attachable for jewellery or mineral observation ■ Movable upon attachment 	 SW0199B3
---	---

SMZ-168 SERIES OPTICAL DATA

Eyepiece	Mag. (X)	Standard Objectives		Auxiliary Objectives											
				0.3X		0.5X		0.63X		0.75X		1.5X		2X	
		WD 113mm		WD 324mm		WD 192mm		WD 156mm		WD 127mm		WD 50mm		WD 34.5mm	
		Mag.	FD (mm)	Mag.	FD (mm)	Mag.	FD (mm)	Mag.	FD (mm)	Mag.	FD (mm)	Mag.	FD (mm)	Mag.	FD (mm)
5X/23	0.75	3.8	30.7	1.1	102.2	1.9	61.3	2.4	48.7	2.8	40.9	5.6	20.4	7.5	15.3
	1	5.0	23.0	1.5	76.7	2.5	46.0	3.2	36.5	3.8	30.7	7.5	15.3	10.0	11.5
	2	10.0	11.5	3.0	38.3	5.0	23.0	6.3	18.3	7.5	15.3	15.0	7.7	20.0	5.8
	3	15.0	7.7	4.5	25.6	7.5	15.3	9.5	12.2	11.3	10.2	22.5	5.1	30.0	3.8
	4	20.0	5.8	6.0	19.2	10.0	11.5	12.6	9.1	15.0	7.7	30.0	3.8	40.0	2.9
6.25X/23	0.75	4.7	30.7	1.4	102.2	2.3	61.3	3.0	48.7	3.5	40.9	7.0	20.4	9.4	15.3
	1	6.3	23.0	1.9	76.7	3.1	46.0	3.9	36.5	4.7	30.7	9.4	15.3	12.5	11.5
	2	12.5	11.5	3.8	38.3	6.3	23.0	7.9	18.3	9.4	15.3	18.8	7.7	25.0	5.8
	3	18.8	7.7	5.6	25.6	9.4	15.3	11.8	12.2	14.1	10.2	28.1	5.1	37.5	3.8
	4	25.0	5.8	7.5	19.2	12.5	11.5	15.8	9.1	18.8	7.7	37.5	3.8	50.0	2.9
10X/23	0.75	7.5	30.7	2.3	102.2	3.8	61.3	4.7	48.7	5.6	40.9	11.3	20.4	15.0	15.3
	1	10.0	23.0	3.0	76.7	5.0	46.0	6.3	36.5	7.5	30.7	15.0	15.3	20.0	11.5
	2	20.0	11.5	6.0	38.3	10.0	23.0	12.6	18.3	15.0	15.3	30.0	7.7	40.0	5.8
	3	30.0	7.7	9.0	25.6	15.0	15.3	18.9	12.2	22.5	10.2	45.0	5.1	60.0	3.8
	4	40.0	5.8	12.0	19.2	20.0	11.5	25.2	9.1	30.0	7.7	60.0	3.8	80.0	2.9
10X/21	0.75	7.5	28.0	2.3	93.3	3.8	56.0	4.7	44.4	5.6	37.3	11.3	18.7	15.0	14.0
	1	10.0	21.0	3.0	70.0	5.0	42.0	6.3	33.3	7.5	28.0	15.0	14.0	20.0	10.5
	2	20.0	10.5	6.0	35.0	10.0	21.0	12.6	16.7	15.0	14.0	30.0	7.0	40.0	5.3
	3	30.0	7.0	9.0	23.3	15.0	14.0	18.9	11.1	22.5	9.3	45.0	4.7	60.0	3.5
	4	40.0	5.3	12.0	17.5	20.0	10.5	25.2	8.3	30.0	7.0	60.0	3.5	80.0	2.6
15X/17	0.75	11.3	22.7	3.4	75.6	5.6	45.3	7.1	36.0	8.4	30.2	16.9	15.1	22.5	11.3
	1	15.0	17.0	4.5	56.7	7.5	34.0	9.5	27.0	11.3	22.7	22.5	11.3	30.0	8.5
	2	30.0	8.5	9.0	28.3	15.0	17.0	18.9	13.5	22.5	11.3	45.0	5.7	60.0	4.3
	3	45.0	5.7	13.5	18.9	22.5	11.3	28.4	9.0	33.8	7.6	67.5	3.8	90.0	2.8
	4	60.0	4.3	18.0	14.2	30.0	8.5	37.8	6.7	45.0	5.7	90.0	2.8	120.0	2.1
20X/13	0.75	15.0	17.3	4.5	57.8	7.5	34.7	9.5	27.5	11.3	23.1	22.5	11.6	30.0	8.7
	1	20.0	13.0	6.0	43.3	10.0	26.0	12.6	20.6	15.0	17.3	30.0	8.7	40.0	6.5
	2	40.0	6.5	12.0	21.7	20.0	13.0	25.2	10.3	30.0	8.7	60.0	4.3	80.0	3.3
	3	60.0	4.3	18.0	14.4	30.0	8.7	37.8	6.9	45.0	5.8	90.0	2.9	120.0	2.2
	4	80.0	3.3	24.0	10.8	40.0	6.5	50.4	5.2	60.0	4.3	120.0	2.2	160.0	1.6
30X/8	0.75	22.5	10.7	6.8	35.6	11.3	21.3	14.2	16.9	16.9	14.2	33.8	7.1	45.0	5.3
	1	30.0	8.0	9.0	26.7	15.0	16.0	18.9	12.7	22.5	10.7	45.0	5.3	60.0	4.0
	2	60.0	4.0	18.0	13.3	30.0	8.0	37.8	6.3	45.0	5.3	90.0	2.7	120.0	2.0
	3	90.0	2.7	27.0	8.9	45.0	5.3	56.7	4.2	67.5	3.6	135.0	1.8	180.0	1.3
	4	120.0	2.0	36.0	6.7	60.0	4.0	75.6	3.2	90.0	2.7	180.0	1.3	240.0	1.0
32X/8	0.75	24.0	10.7	7.2	35.6	12.0	21.3	15.1	16.9	18.0	14.2	36.0	7.1	48.0	5.3
	1	32.0	8.0	9.6	26.7	16.0	16.0	20.2	12.7	24.0	10.7	48.0	5.3	64.0	4.0
	2	64.0	4.0	19.2	13.3	32.0	8.0	40.3	6.3	48.0	5.3	96.0	2.7	128.0	2.0
	3	96.0	2.7	28.8	8.9	48.0	5.3	60.5	4.2	72.0	3.6	144.0	1.8	192.0	1.3
	4	128.0	2.0	38.4	6.7	64.0	4.0	80.6	3.2	96.0	2.7	192.0	1.3	256.0	1.0
5	160.0	1.6	48.0	5.3	80.0	3.2	100.8	2.5	120.0	2.1	240.0	1.1	320.0	0.8	

Note : "WD" represents Working Distance, "Mag." represents Magnification, "FD" represents Field Diameter.

SMZ-168 SERIES ILLUMINATION / STANDS

K2401 FLUORESCENT RING ILLUMINATOR

- Colour Temperature: 6400K
- Even white light
- 12W power consumption
- Specifically designed attachment for SMZ-168



MLC-150 COLD LIGHT SOURCE

- Colour Temperature Indication
- Colour Temperature Range: 2500K - 3200K
- Remote or local intensity control
- 21V / 150W switching power
- Filter holder



LIGHT GUIDE OPTIONS



Flexible ring light guide
SP990074



1 Arm gooseneck type light guide
SP990075



2 Arm gooseneck type light guide
SP990076

SMZ-168 SERIES CHOICE OF BASE STANDS

Universal Stand



- Diameter of base 380mm
- Diameter of vertical pole 25mm
- Height of pole 200mm
- Diameter of pole for focusing mount 32mm

Special Universal Stand



- Length of base 250mm
- Height of pole 373mm
- Width of base 250mm
- Diameter of pole for focusing mount 32mm

Ball Bearing Boom Stand



- Diameter of vertical pole 36mm
- Diameter of pole for focusing mount 32mm

Ball Bearing Boom Stand



- Diameter of vertical pole 36mm
- Diameter of pole for focusing mount 32mm

Articulating Arm Boom Stand



- Diameter of vertical pole 36mm
- Diameter of pole for focusing mount 32mm

Articulating Arm Boom Stand



- Diameter of vertical pole 36mm
- Diameter of pole for focusing mount 32mm

□ Some illuminators and stands may not be available in your area. Please check with your local sales office.

SMZ-168 SERIES SYSTEM DIAGRAM

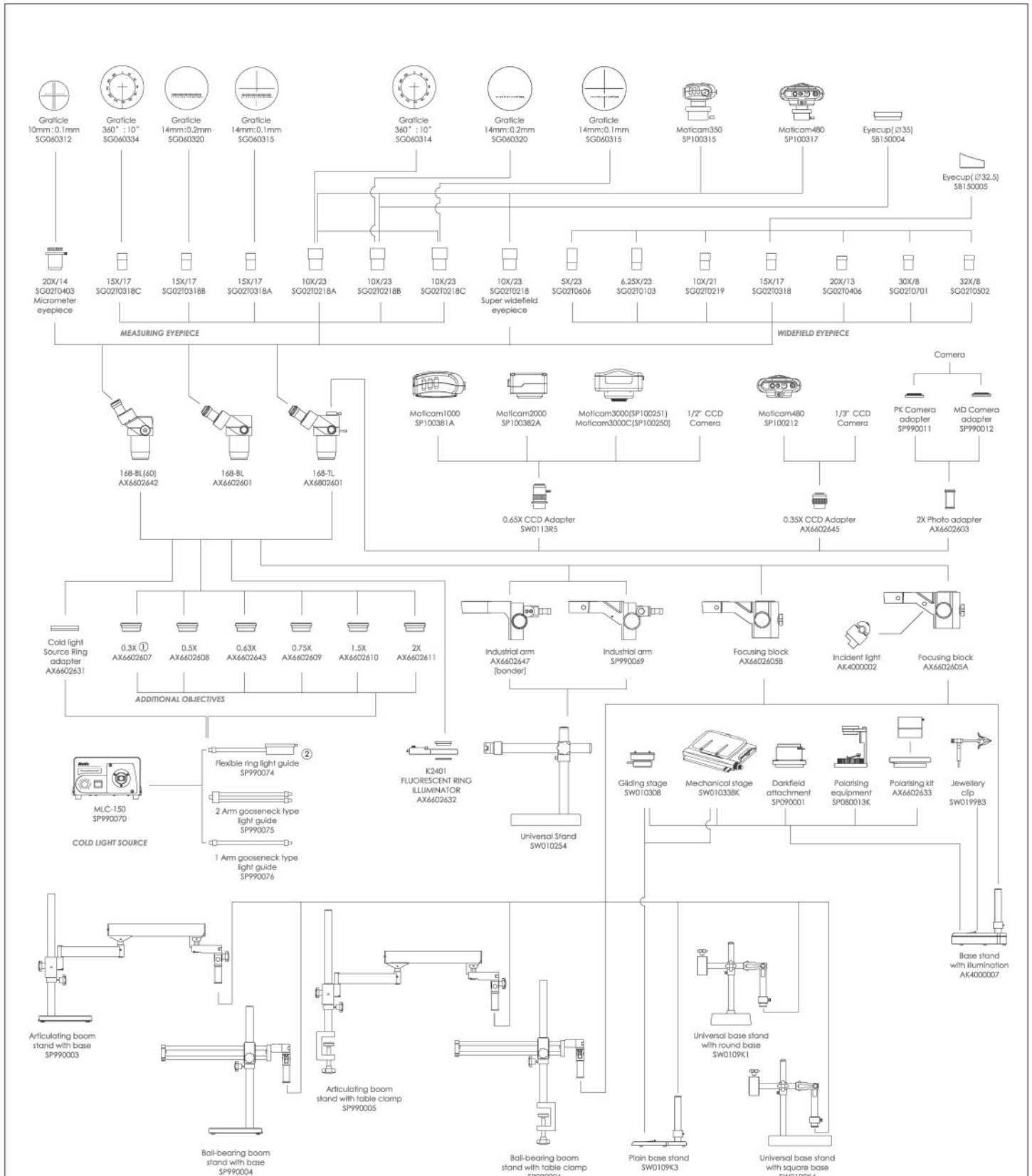

- ① Special long pole of 450mm required to use with 0.3X objective.
- ② When using the cold light source ring light guide, you need to select item number AX6602631 for proper fit
- * When selecting the fluorescent ring illuminator, please note the country plug and voltage required.

Motic[®] Microscopes

Motic[®]

www.motic.com

Motic Incorporation Ltd. (HONG KONG)

Rm 2907-8, Windsor House, 311 Gloucester Road, Causeway Bay, Hong Kong

Tel: 852-2837 0888 Fax: 852-2882 2792

Motic Instruments Inc. (CANADA)

180-4320 Viking Way Richmond, B.C. V6V 2L4 Canada

Tel: 1-877-977 4717 Fax 1-604-303 9043

For inquiries in UK (UK)

Saracens House, 25 St. Margarets Green, Ipswich, IP4 2BN, Suffolk, UK

Tel: 44-(0)-14732 81909 Fax 44-(0)-14732 11508

Motic Deutschland GmbH (GERMANY)

Gewerbepark Spilburg, Spilburgstrasse 1 D-35578 Wetzlar Germany

Tel: 49-6441-210 010 Fax 49-6441-210 0122

Motic Spain, S.L. (SPAIN)

C/Pere IV, 78-84-7 Planta 08005 Barcelona Spain

Tel: 34-93-485 1841 Fax 34-93-309 7700

Motic Incorporation Ltd. Copyright © 2002-2004. All Rights Reserved

Design Change: The manufacturer reserves the right to make changes in instrument design in accordance with scientific and mechanical progress, without notice and without obligation.

CE



Code No: SP010874B

SteREO Discovery.V8

A New View of Things



**Brilliant Entry into the Class of
Sophisticated Stereomicroscopes**



We make it visible.

SteREO Discovery.V8: Enhanced Viewing

New high-performance optics – this is the outstanding performance feature that Carl Zeiss has focused on with the development of its latest entry level model in the sophisticated stereomicroscope class. The SteREO Discovery.V8 impresses with enhanced resolution, increased contrast and, most notably, a perceptibly improved stereoscopic impression. As a result, it offers a image brilliance that is without equal in this class of instrument. For a visible increase in information in all biomedical and industrial applications, the time has come for a new view of things.

SteREO Discovery.V8 at a glance:

- Supreme ease of operation and ergonomic viewing posture
- Zoom range of 8 : 1
- Optimized optics design for a visible increase in image information
- Manual focusing drive with adjustable click stops
- Manual and motorized stands with high stability
- Generous specimen space with high working distance
- Illumination and contrast methods based on cold light and LED



PCB
Laterally grazing reflected light
Objective: Plan S 1.0x
Magnification: 16x*

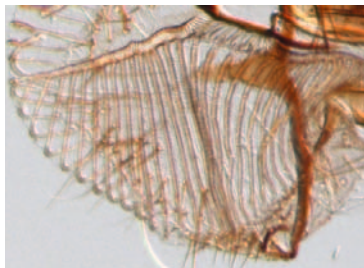

Mouth parts of the common housefly
Oblique illumination in brightfield
transmitted light
Objective: PlanApo S 1.0x
Magnification: 80x*

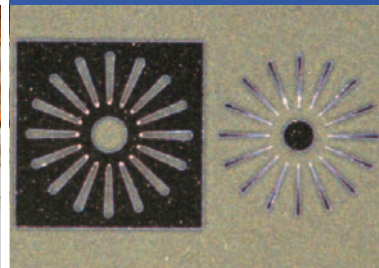

Wafer structure
Darkfield reflected light
Objective: PlanApo S 1.5x
Magnification: 120x*

SteREO Discovery.V8

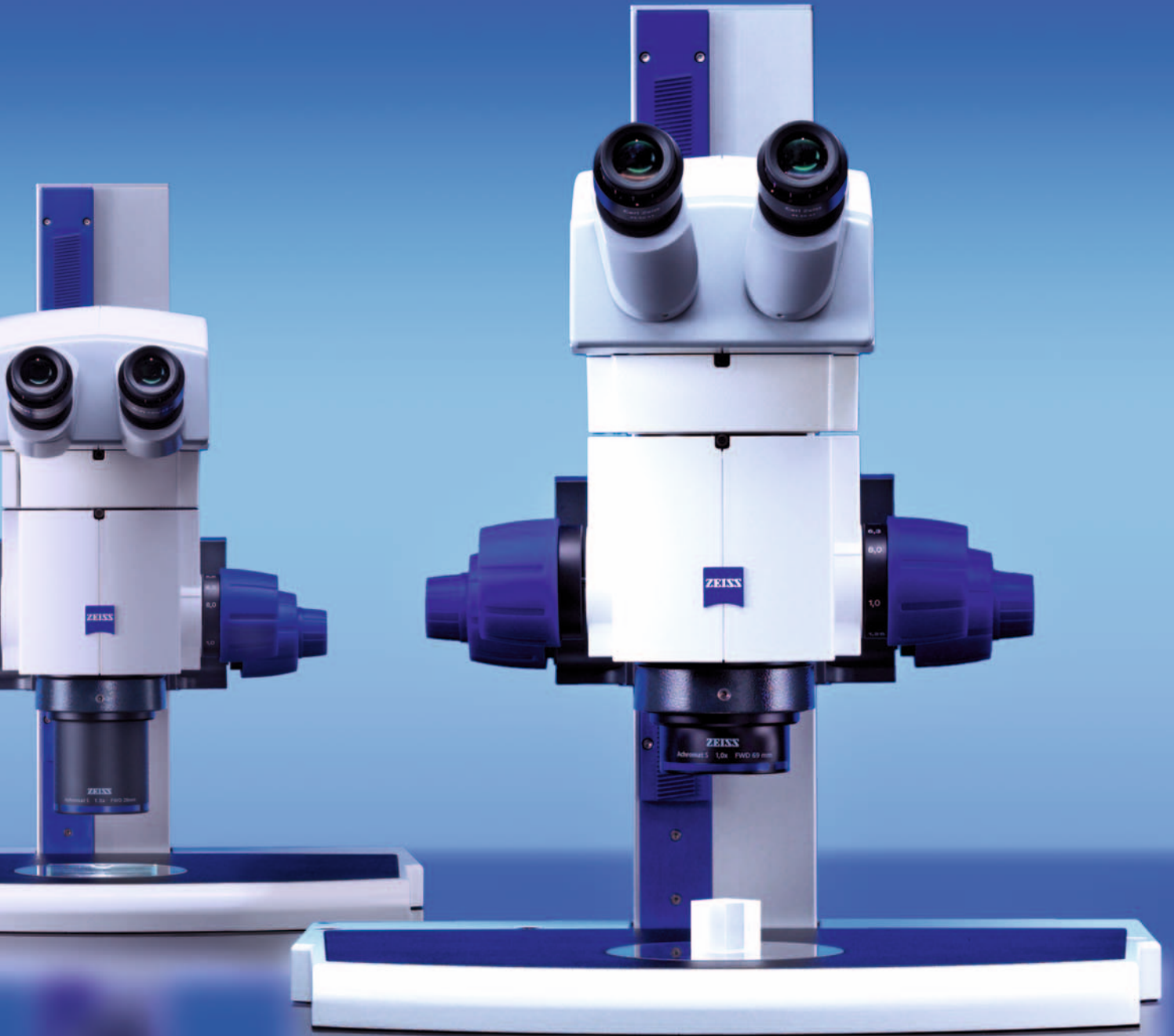

The Optical System: More Than the Sum of its Individual Components

Today, anyone developing a stereomicroscope that sets new standards with its optical system has to work constructively at the very limits of physical feasibility, taking full advantage of every new possibility offered by state-of-the-art optical design. With experience and innovativeness, you don't have to look any further than the optical systems from Carl Zeiss.

The innovative simultaneous design process during optical modeling has resulted in a standardized optical concept for all SteREO microscopes. For significantly improved resolution and a perceptibly better

stereoscopic impression of the microscopic image. Even on our SteREO Discovery.V8 entry level model.

Another area we focused on during practical realization was the systematic minimization of stray light for the entire optical system. For exceptionally brilliant contrast and a new image quality with greater information content.

3 ranges of high-quality objectives
Achromat S: high-contrast images with a pronounced stereoscopic impression
Plan S: flat, distortion-free object fields
PlanApo S: precisely detailed resolution with no color fringes

Parfocally harmonized for needle-sharp images over the entire magnification range from 1x to 8x: the new zoom body of SteREO Discovery.V8

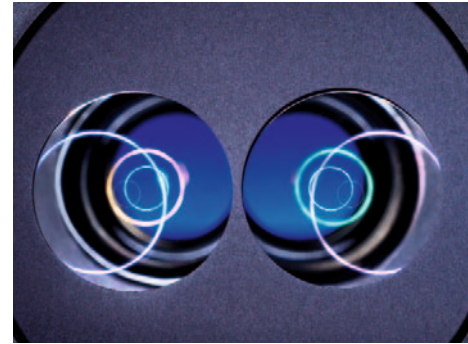

Contrasts with variable optimization in brightfield, darkfield and oblique light: the transmitted light equipment S



The Illumination: Show Your Specimen in a New Cold Light

The quality of the illumination – this is all-important for contrasting in stereomicroscopy. The new fiber-optic CL 1500 ECO cold light source with its wide range of light guides and accessories offers you a variety of opportunities for highlighting your structures perfectly.

Designed for slimline, space-saving light guides, optimized for flicker-free live images on the monitor, providing constant light output even if the line voltage fluctuates, and with ventilation as quiet as a whisper – the high-intensity CL 1500 ECO cold light

source outperforms conventional fiber-optic systems thanks to several practical advantages, and offers excellent performance at a superb price!

Incidentally, lamps and filters can be changed quickly and conveniently. Even when stacked.

The fiber-optic CL 1500 ECO cold light source illuminates the specimen precisely with intensive infrared-free light. Here with a twin-arm goose neck for oblique reflected light with a targeted shadow effect.

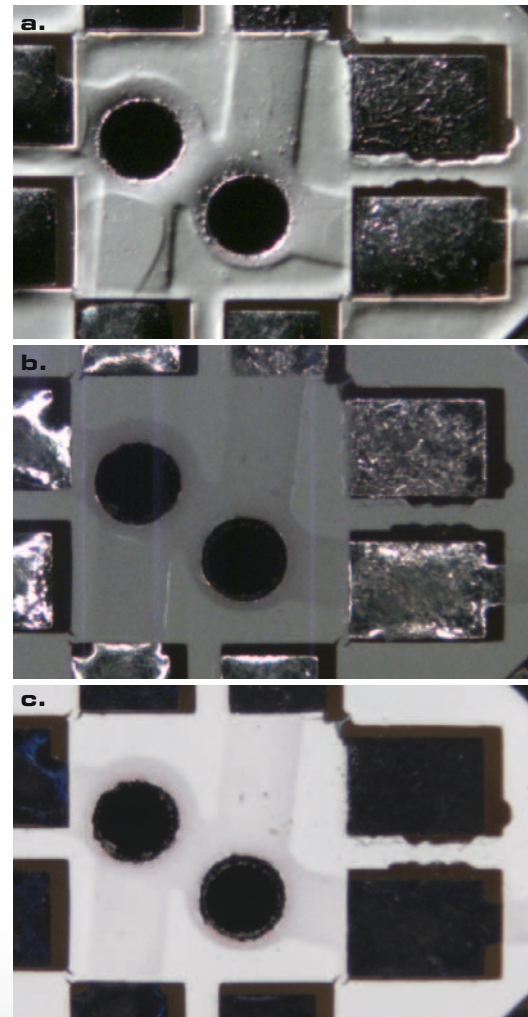

SMD-Board with white solder resist
Reflected light with different light guides
a. Linear slit light for lateral grazing light
b. Fiber-optic annular slit illuminator for shadow-free 360° reflected light
c. Annular slit illuminator with polarization filter device to minimize reflective glare
Objective: Plan S 1.0x
Magnification: 15x

Quiet, durable and offering the best in daylight quality: VisiLED LED illumination

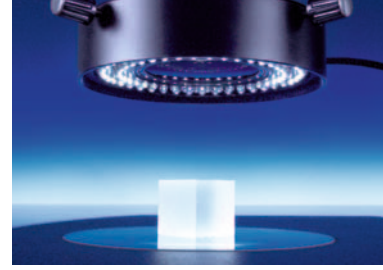

Or in a Completely Different Light: With White LEDs

Providing the ability to change rapidly from shadow-free annular illumination to lateral oblique light, contrast optimization through turning of oblique light around the specimen, continuous rotation of the illumination for a stereoscopic impression of the object in the live image – and all this at the push of a button! The list of new contrasting possibilities offered by the VisiLED illumination system with its white LEDs is endless!

Each of the annular VisiLED illuminators is made up of eight LED segments that can be switched variably. A further advantage of noise-free light sources: up

to 4 illumination settings can be stored and reproduced again at any time.

The MC1500 multicontroller of the VisiLED system allows control of reflected, transmitted and blended light.

The VisiLED HCT contrast stage offers a wide range of contrasts. It contains separate LED illuminators for brightfield and darkfield, and sliders for finely adjustable oblique light. The LEDs are controlled using the MC1500 multicontroller.

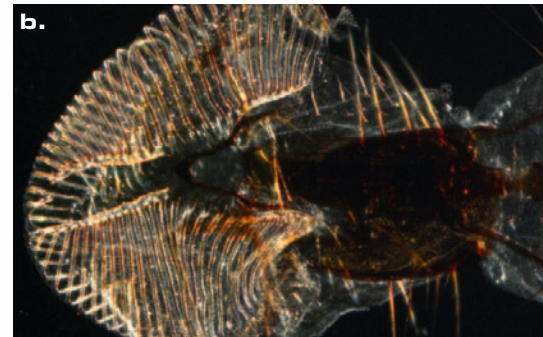

*Mouth parts of the common housefly
Transmitted light with VisiLED HCT contrast stage
a. Brightfield
b. Lateral darkfield
c. Oblique brightfield illumination
Objective: PlanApo S 1.0x
Magnification: 80x*

The Expandable Platform: Flexible For a Variety of Applications

A typical feature of stereomicroscopes is their modular system design. Equipped with intelligent interfaces and fully integrated into the Carl Zeiss systems, SteREO Discovery.V8, with its comprehensive range of accessories, offers you a great deal of freedom in terms of organizing your workplace to suit your own practical needs.

1. Interface with digital image worlds: documentation

SteREO Discovery.V8 creates a connection for a variety of digital photo and video cameras, via various phototubes, with interface 60N. For the simple documentation of stereomicroscopic images, consumer cameras, with their good price/performance ratio, are often recommended. Anyone wishing to satisfy higher demands should use the high-resolution AxioCam microscope cameras and the AxioVision imaging software from Carl Zeiss.

2. Brilliant fluorescence: PentaFluar S

PentaFluar S is the name of the retrofittable fluorescence equipment for stereomicroscopes belonging to the SteREO Discovery family. With up to five different filter blocks in the magazine and special high-performance light sources, this is an outstanding addition for contemporary fluorescence applications in stereomicroscopy.

3. Better in position: the binocular ergo-phototube S 5-45°

Ergonomics is also about choosing a relaxed sitting position when operating a microscope. The viewing angle and height have to coincide. The ergotube allows a free choice of viewing angle between 5 and 45 degrees. Intermediate tubes and two working positions for the eyepiece clamps vary the viewing height.

4. Vertical 2D impression: the objective slide

A must for documentation with subsequent image analysis, e.g. digital object measurements: the S/doc objective slide for the SteREO Discovery family of microscopes. Positioned directly beneath the zoom body, it enables the objective to be shifted precisely under one of the stereoscopic beam paths for a vertical view of your specimen.



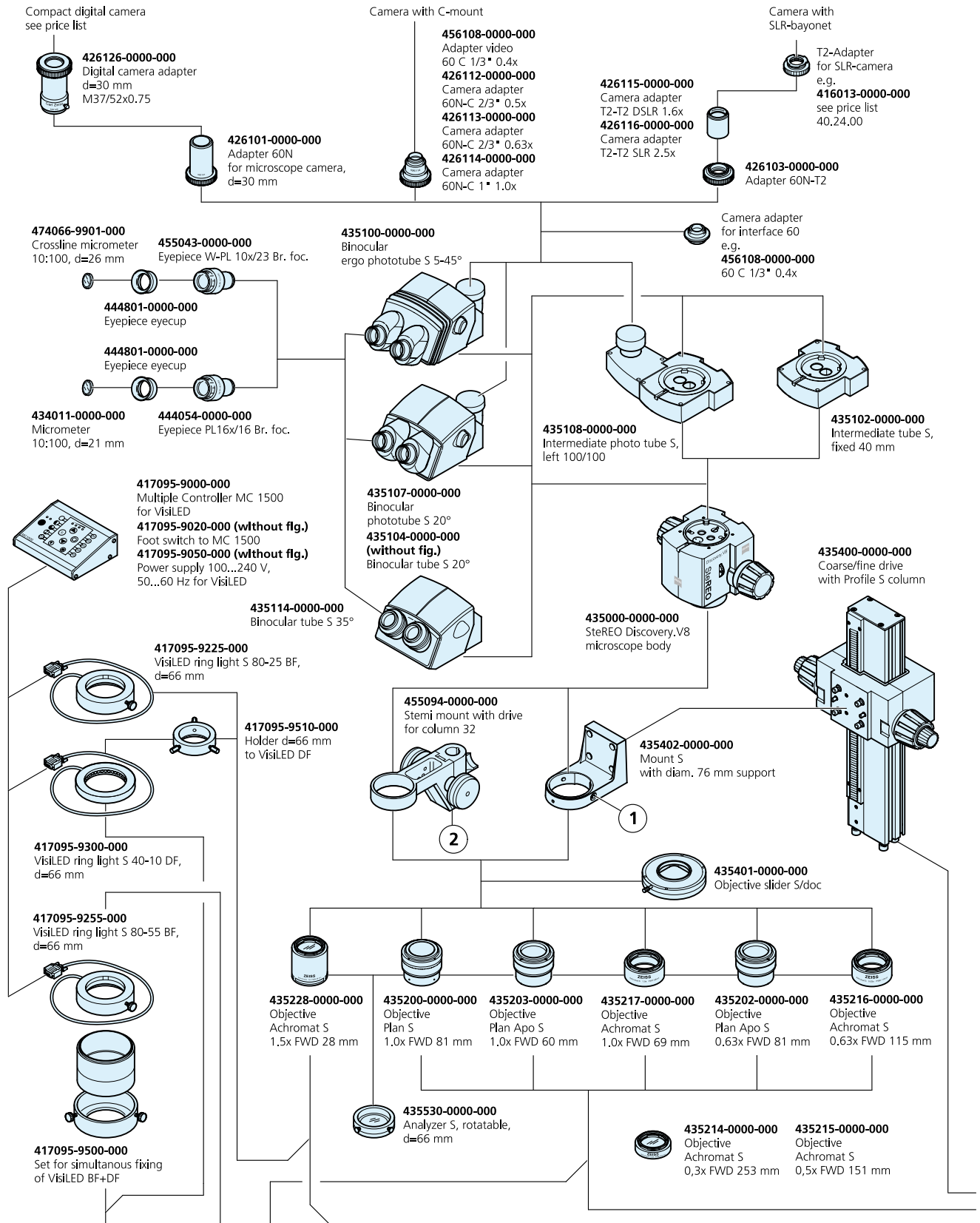

System Overview

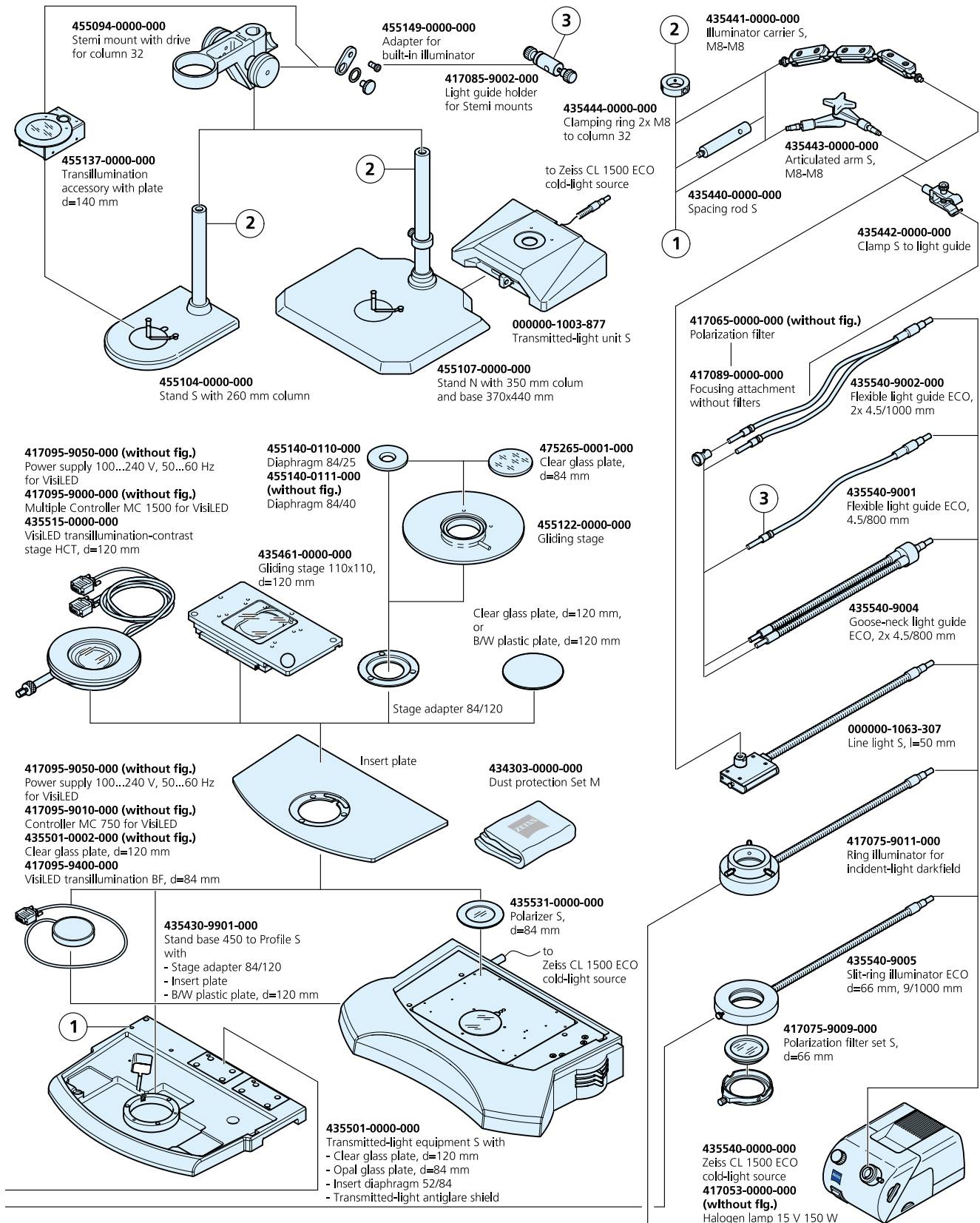

SteREO Discovery.V8: The Technical Data

Objectives		Eyepieces					
Description	FWD	WPL 10x/23 Br. foc		PL 16x/16 Br. foc		W 25x/10 foc	
Factor	(mm)	Magnification	Object Field (mm)	Magnification	Object Field (mm)	Magnification	Object Field (mm)
PlanApo S 0,63x	81	6,3x ... 50,4x	36,5 ... 4,6	10,1x ... 80,6x	25,4 ... 3,2	15,8x ... 126x	15,9 ... 2,0
PlanApo S 1,0x	60	10x ... 80x	23,0 ... 2,9	16x ... 128x	16,0 ... 2,0	25x ... 200x	10,0 ... 1,3
PlanApo S 1,5x	30	15x ... 120x	15,3 ... 1,9	24x ... 192x	10,7 ... 1,3	37,5x ... 300x	6,7 ... 0,8
Plan S 1,0x	81	10x ... 80x	23,0 ... 2,9	16x ... 128x	16,0 ... 2,0	25x ... 200x	10,0 ... 1,3
Achromat S 0,3x	253	3x ... 24x	76,7 ... 9,6	4,8x ... 38,4x	53,3 ... 6,7	7,5x ... 60x	33,3 ... 4,2
Achromat S 0,5x	151	5x ... 40x	46,0 ... 5,8	8x ... 64x	32,0 ... 4,0	12,5x ... 100x	20,0 ... 2,5
Achromat S 0,63x	115	6,3x ... 50,4x	36,5 ... 4,6	10,1x ... 80,6x	25,4 ... 3,2	15,8x ... 126x	15,9 ... 2,0
Achromat S 1,0x	69	10x ... 80x	23,0 ... 2,9	16x ... 128x	16,0 ... 2,0	25x ... 200x	10,0 ... 1,3
Achromat S 1,5x	28	15x ... 120x	15,3 ... 1,9	24x ... 192x	10,7 ... 1,3	37,5x ... 300x	6,7 ... 0,8

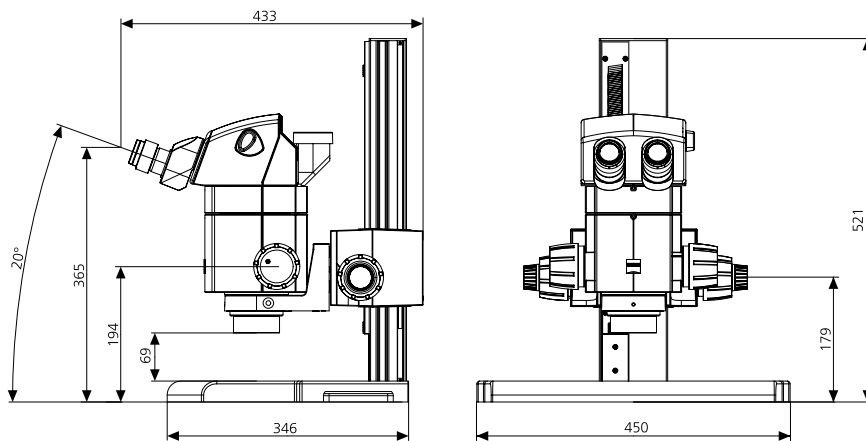

Carl Zeiss Microlmaging GmbH

P.O.B. 4041, 37030 Göttingen, Germany

Phone: +49 551 5060 660

Fax: +49 551 5060 464

E-mail: micro@zeiss.de

www.zeiss.de/stereo-discovery